

RoHS2.0

REV.	ECN NO.	APPD.
X1	20231014-003	Alvin Zhang
X2	20240108-001	Alvin Zhang

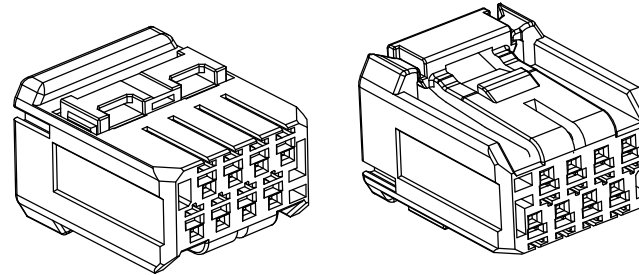
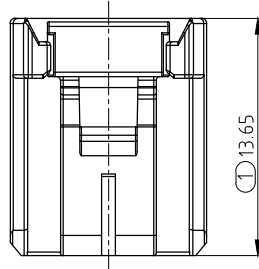

NOTE

- Applicable wire: AES SX 0.3mm², UL3265 0.3mm², Equivalent to AWG#22, Insulation O. D. Ø1.5mm Max.
- Complicant with ROHS
- TPA二次锁扣后端子保持力: 30N Min.
- DATA CODE: 共计七位 XX XX XX X

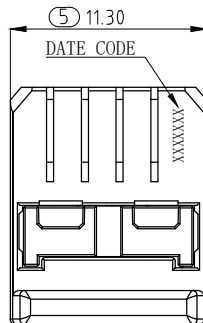
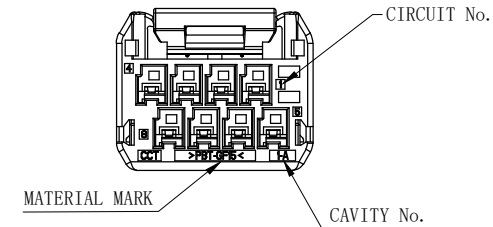
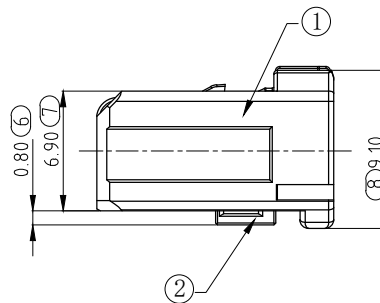
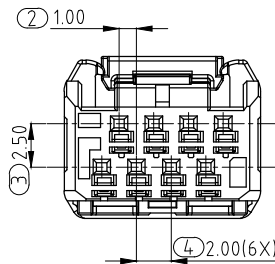
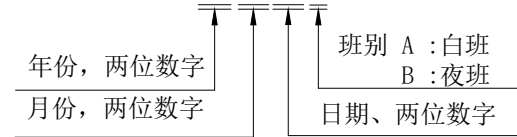

BOM

NO.	NAME	MATERIAL	QUANTITY
2	TPA	PBT GF15%(Blue)	1
1	HOUSING	PBT GF15%(Black)	1

TOLERANCES UNLESS OTHERWISE SPECIFIED		UNITS	COCENTRA 科信成精密技术 (江苏) 有限公司 COCENTRA PRECISION TECHNOLOGY (JIANGSU) Co. LTD		
X± 0.35	X*± 2°	mm	DWG NAME: CUSTOMER DRAWING TITLE: CCTCPM8PIN线端连接器 (Black)		
.X± 0.30	.X*± 1°	NA	APPD: David Wang 2024/01/08 PART NO.: BMP208-B26-PB		
.XX± 0.25	.XX*± 0.5°	FINISH NA	CKD: DWG NO.: 307-0000-0451		
THESE DRAWINGS AND SPECIFICATIONS ARE THE PRIOR WRITTEN CONSENT OF COCENTRA PRECISION TECHNOLOGY (JIANGSU) Co. LTD. AND SHALL NOT BE REPRODUCED, COPIED OR USED IN ANY MANNER WITHOUT THE PRIOR WRITTEN CONSENT OF COCENTRA PRECISION TECHNOLOGY (JIANGSU) Co. LTD.		Q'TY NA	DR: Y. P. Chen 2024/01/08		SCALE NA
			SHEET 1/1	REV. X2	