

零件图

Rev.	ECN No.	DESCRIPTION

RoHS 2.0+HF

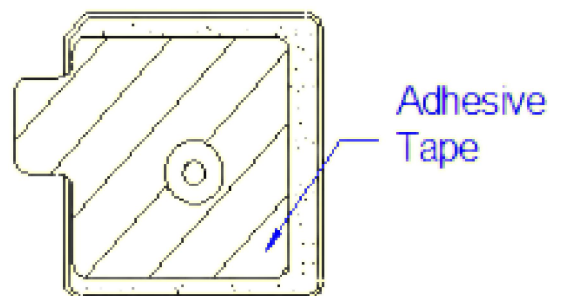
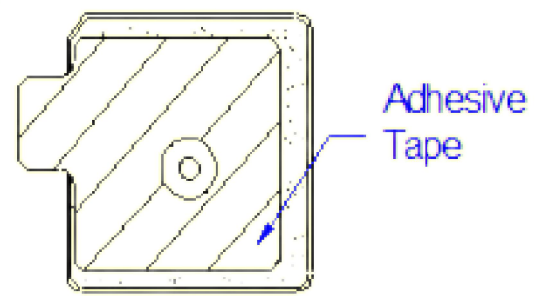
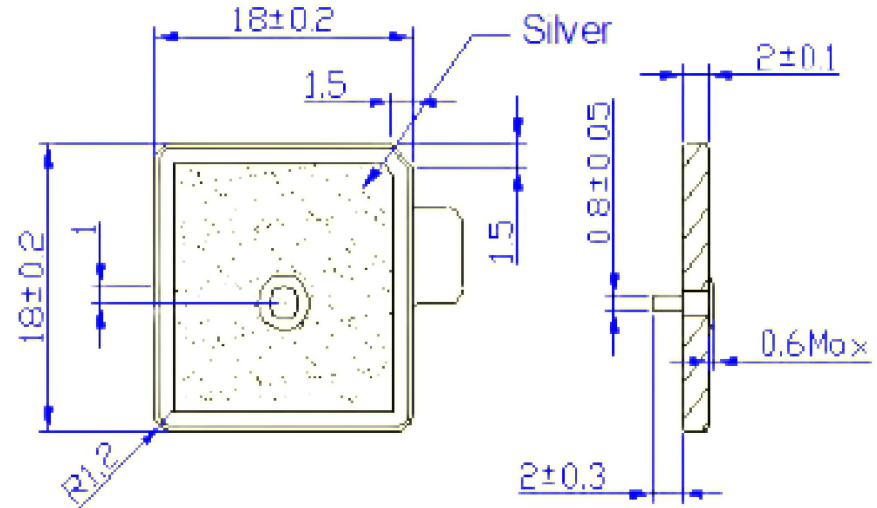
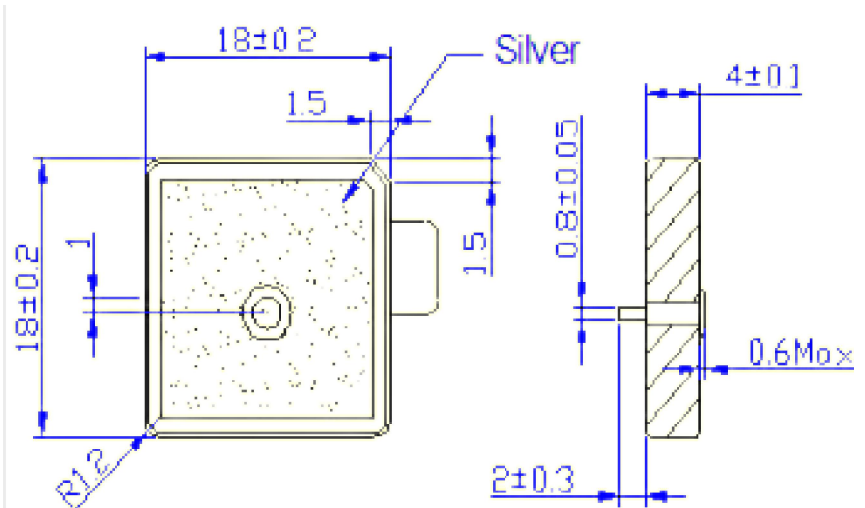

客户料号				/			
TOLERANCES UNLESS OTHERWISE SPECIFIED				COCENTRA® 科信成精密技术 (江苏) 有限公司 COCENTRA PRECISION TECHNOLOGY (JIANGSU) Co. LTD.			
X.	/	X.°	±2°	SERIES:		TITLE:	
.X	±0.30	.X°	±1°	APPD:		CCT-TC-182/4	
.XX	±0.20	.XX°	±0.5°	CKD:		PART No.:	
THESE DRAWINGS AND SPECIFICATIONS ARE THE PRIOR WRITTEN CONSENT OF COCENTRA PRECISION TECHNOLOGY (JIANGSU) Co. LTD. AND SHALL NOT BE REPRODUCED. COPIED OR USED IN ANY MANNER WITHOUT THE PRIOR WRITTEN CONSENT OF COCENTRA PRECISION TECHNOLOGY (JIANGSU) Co. LTD.				DR:		DWG No.:	
				UNITS	MAT'L	FINISH	SCALE
MM		N/A	N/A	1:1	1/1	X1	